



CARRARO

Catalogo Parti Di Ricambio

Spare Parts List

ASSALE 26.00

26.00 AXLE

REF. 148394

- 1.0.0 Corpo assale
Axle housing
- 2.0.0 Calotte e cilindro di sterzo
Swivel housings and steering cylinder
- 3.0.0 Mozzo ruota
Wheel hub
- 4.0.0 Sommario kit
Kit summary

Il presente catalogo è valido a partire dal N° di matricola 101.

This catalogue is valid from serial number 101.

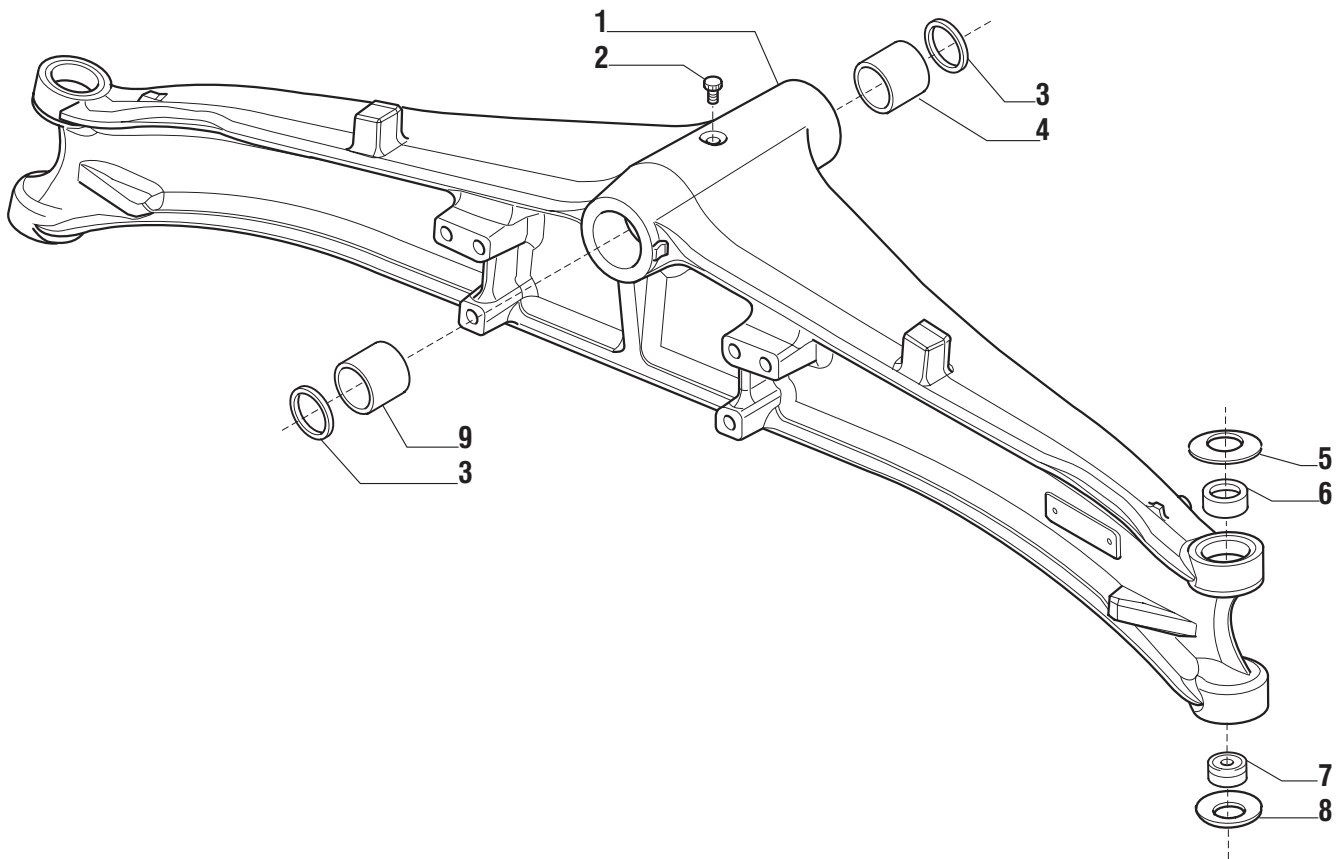

Pos.	Ref.	Q.ty	Descrizione	Description	Kit	Note
1	145561	1	Trave	Axle housing		
2	030803	1	Tappo 7/16-20	Plug 7/16-20		
3	120717	2	Anello tenuta	Seal ring		
4	126611	1	Boccola	Bushing		
5	125813	2	Molla a tazza	Belleville washer		
6	144557	2	Boccola	Bushing		
7	123726	2	Rotula sferica	Spherical bearing		
8	128630	2	Molla a tazza	Belleville washer		
9	126610	1	Boccola	Bushing		

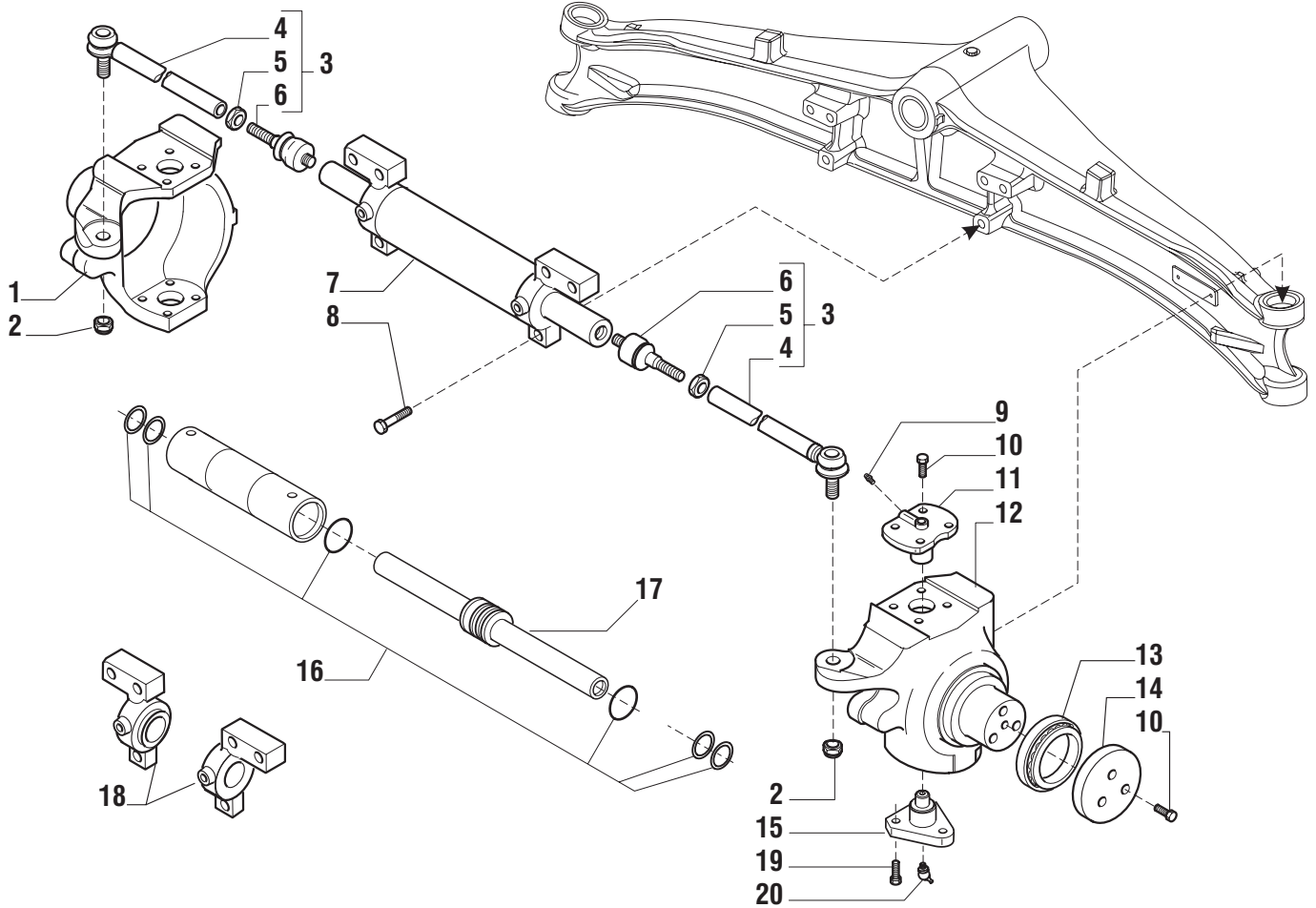

Pos.	Ref.	Q.ty	Descrizione	Description	Kit	Note
1	144867	1	Calotta SX	LH Swivel housing		
2	022437	2	Dado M18x1.5	Nut M18x1.5		
3	134036	2	Asta guida	Steering arm assy		
4	351219	2	Tirante	Tie rod		
5	022183	2	Dado M18x1.5	Nut M18x1.5	134036	
6	350440	2	Snodo sferico	Ball joint	134036	
7	143530	1	Martinetto	Cylinder assembly		
8	021696	6	Vite M16x70	Bolt M16x70		
9	024210	2	Ingrassatore M6x1	Greaser nipple M6x1		
10	126921	14	Vite M12x30	Bolt M12x30		
11	128904	2	Perno snodo	King pin		
12	144866	1	Calotta DX	RH Swivel housing		
13	143682	2	Cuscinetto	Bearing		
14	143173	2	Ralla	Thrust washer		
15	128881	2	Perno snodo	King pin		
16	049311	1	Kit guarnizioni	Seals kit	143530	
17	049218	1	Stelo completo	Assembled rod	143530	
18	049312	1	Testata martinetto DX	RH Cylinder head	143530	
18	049313	1	Testata martinetto SX	LH Cylinder head	143530	
19	126922	6	Vite M14x35	Bolt M14x35		
20	024211	2	Ingrassatore M6x1	Greaser nipple M6x1		

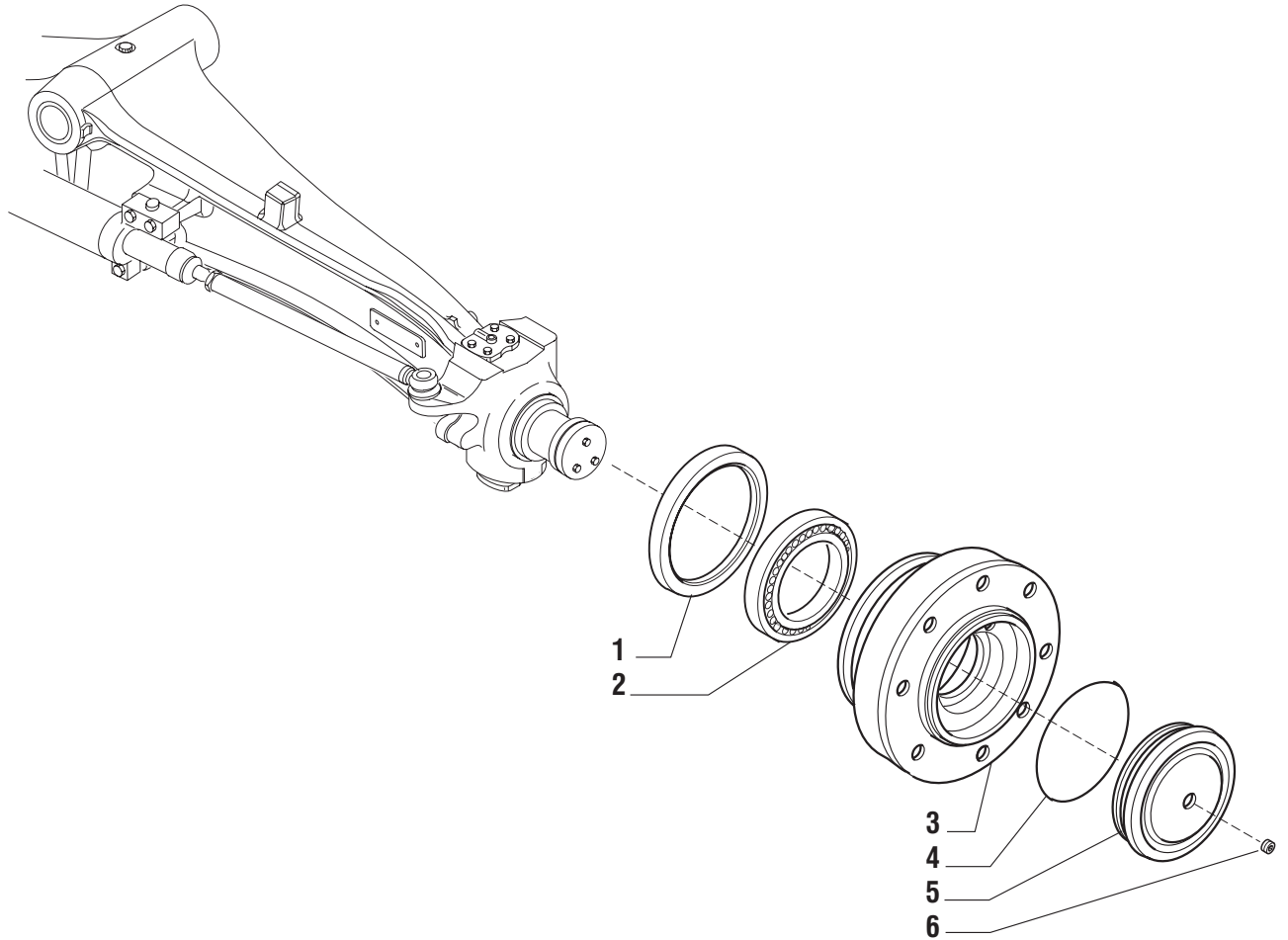

Pos.	Ref.	Q.ty	Descrizione	Description	Kit	Note
1	047703	2	Anello di tenuta	Seal ring		
2	134293	2	Cuscinetto	Bearing		
3	143175	2	Mozzo ruota	Wheel hub		
4	028550	2	Anello OR	O ring		
5	143531	2	Coperchio mozzo ruota	Wheel hub cover		
6	021558	2	Tappo M10x1	Plug M10x1		

Kit	Ref.	Descrizione	Description	Q.ty	Note
134036	-	Asta guida	Steering arm assy	-	
	351219	Tirante	Tie rod	1	
	022183	Dado M18x1.5	Nut M18x1.5	1	
	350440	Snodo sferico	Ball joint	1	
143530	-	Martinetto	Cylinder assembly	-	
	049311	Kit guarnizioni	Seal kit	1	
	049218	Stelo completo	Assembled rod	1	
	049312	Testata martinetto DX	RH Cylinder head	1	
	049313	Testata martinetto SX	LH Cylinder head	1	